

Fișă tehnică | Număr articol: 221-510

Suport de montaj; Seria 221 - 6 mm²; pt mont. pe șină DIN 35/montare cu șurub; portocaliu

www.wago.com/221-510

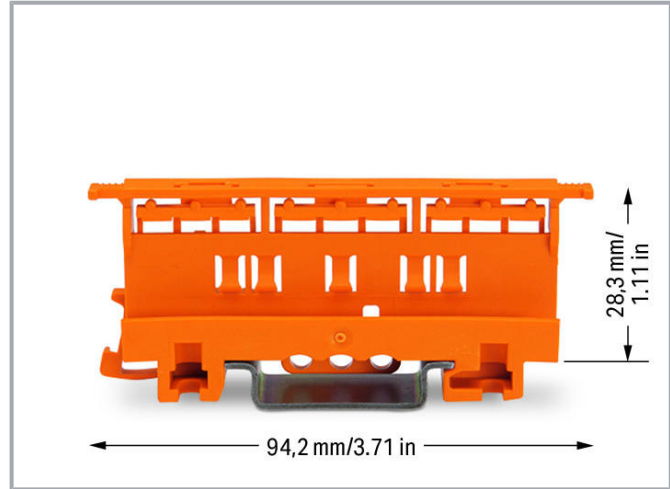
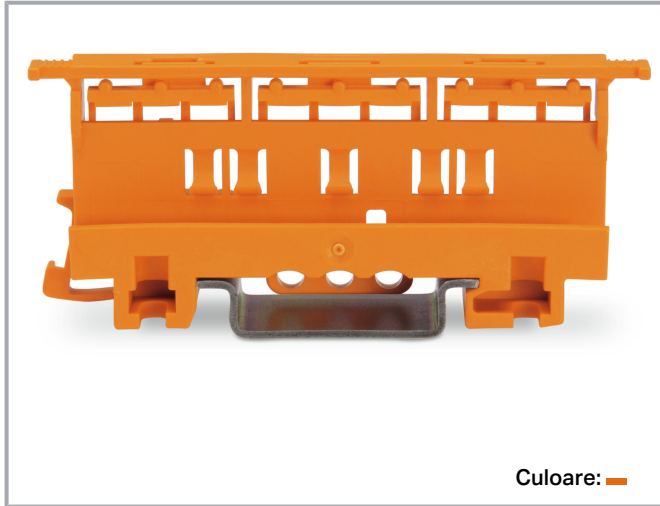

Date

Physical data

Width	19,3 mm / 0.76 inch
Height	94,2 mm / 3.709 inch
Depth from upper edge of DIN-rail	28,3 mm / 1.114 inch

Mechanical data

Mounting type	DIN-35 rail Screw mount
Suitable	for 2-, 3- and 5-conductor 221 Series Splicing Connectors (6 mm ²)

Material data

Color	orange
Insulation material	Polyamide (PA66)
Flammability class per UL94	V0
Weight	11,9 g

Supus modificărilor. Vă rugăm să respectați și celelalte documentații ale produsului!



WAGO Kontakttechnik GmbH & Co. KG
/Representative Office Romania
Sos. Pipera-Tunari nr. 1/1
building 1, 2nd floor | 077190 Voluntari, Ilfov
Tel.: +40-(0)31 421 85 68 | Email: info-RO@wago.com

Aveți întrebări despre produsele noastre?
Vă stăm la dispoziție pentru preluarea apelului la +40 (0) 31 421 85 68.

**Commercial data**

Packaging type	BOX
Country of origin	CN
GTIN	4055143736695
Customs tariff number	39269097900

Produse compatibile**Mounting adapter**

	Nr. articol: 222-505 Placă pentru detensionare; pentru suport de montare; seria 221 sau 222, poate fi înclchetată	www.wago.com/222-505
	Nr. articol: 222-510 Adaptor cu cot șină DIN; în combinație cu suport de montare; 221-500 sau 222-500; pentru montare pe șină DIN 35; gri	www.wago.com/222-510

Marking accessories

	Nr. articol: 210-833 Benzi de marcaj; pe bobină; Lățime de 6 mm; simplu;; Auto-adeziv; alb	www.wago.com/210-833
---	--	--

Descărcări**Documentation****Bid Text**

221-510 X81 - Datei	19.02.2019	xml 2,7 kB	Descărcare
221-510 docx - Datei	23.01.2019	docx 14,9 kB	Descărcare

Additional Information

Technical explanations	03.04.2019	pdf 2,2 MB	Descărcare
------------------------	------------	---------------	------------

CAD/CAE-Data**CAD data**

2D/3D Models 221-510	URL	Descărcare
----------------------	-----	------------

CAE data**ZUKEN Portal 221-510**

Supus modificărilor. Vă rugăm să respectați și celelalte documentații ale produsului!

WAGO Kontakttechnik GmbH & Co. KG
/Representative Office Romania
Sos. Pipera-Tunari nr. 1/1
building 1, 2nd floor | 077190 Voluntari, Ilfov
Tel.: +40-(0)31 421 85 68 | Email: info-RO@wago.com

Aveți întrebări despre produsele noastre?
Vă stăm la dispoziție pentru preluarea apelului la +40 (0) 31 421 85 68.

Note de instalare

Conductor termination

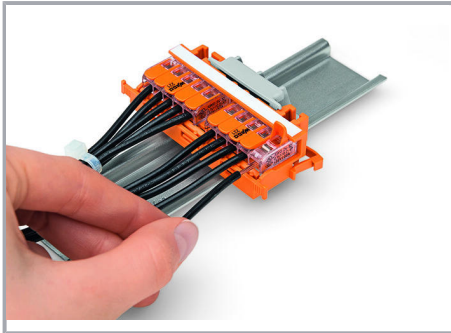

CAGE CLAMP® connection:

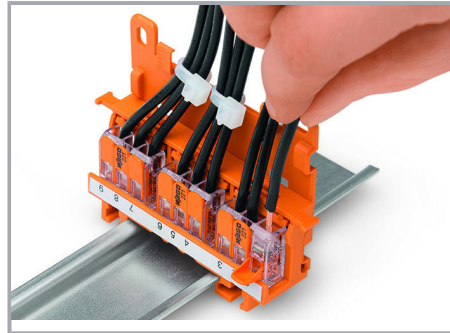

Removing a conductor.

Conductor termination with connectors fitted in a mounting carrier

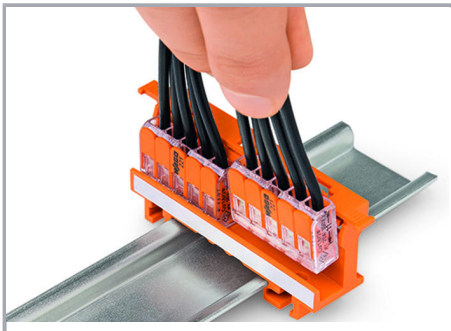

Inserting a connector into the mounting carrier.



Inserting a connector into the mounting carrier.

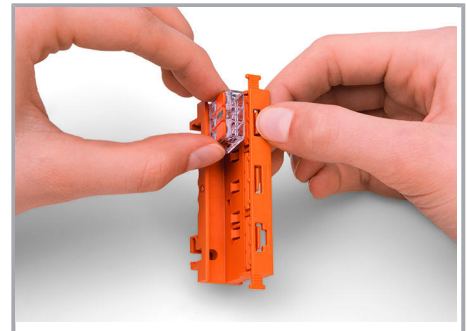

Removing a connector from the mounting carrier.

Supus modificărilor. Vă rugăm să respectați și celelalte documentații ale produsului!

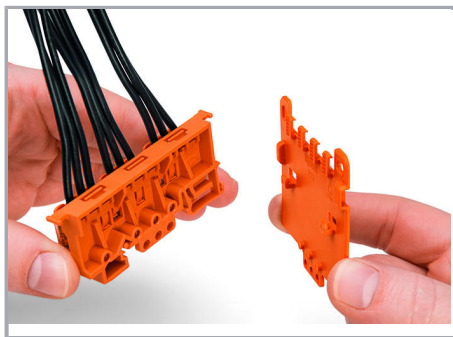

Securing a strain relief plate (222-505) to the mounting carrier.

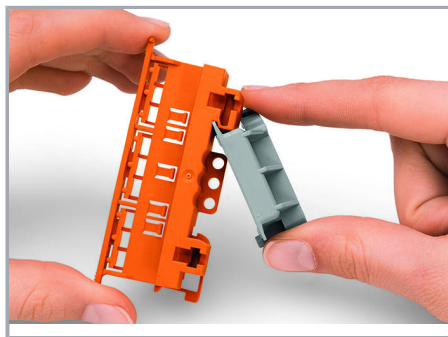

Snapping the angled DIN-rail adapter (222-510) onto the mounting carrier.

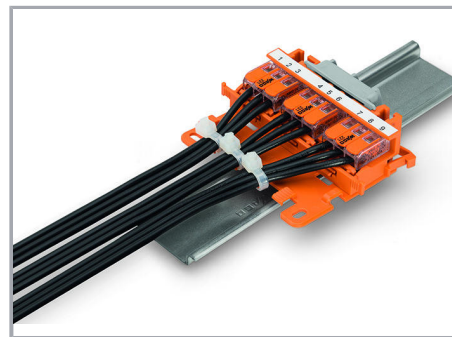

Horizontal mounting on DIN-35 rail using an angled DIN-rail adapter

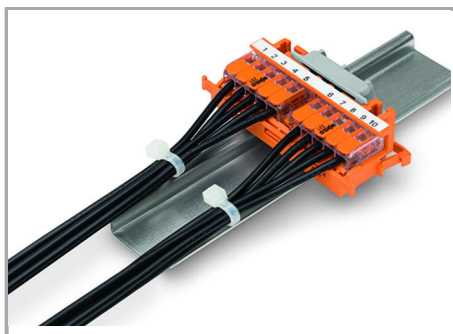

Horizontal mounting on DIN-35 rail using an angled DIN-rail adapter

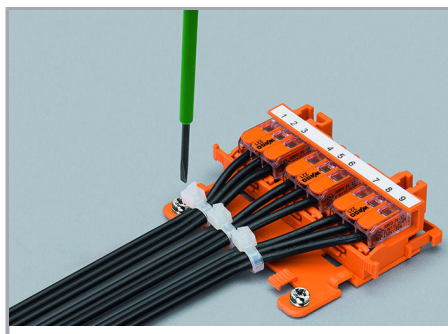

Horizontal screw mounting with strain relief plate on a flat surface



Vertical mounting with strain relief plate on DIN-35 rail

Supus modificărilor. Vă rugăm să respectați și celelalte documentații ale produsului!

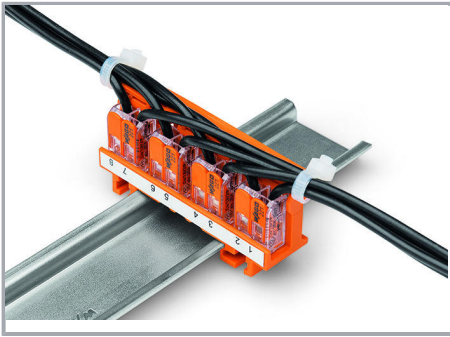

Strain relief via cable ties on the mounting carrier (transverse to the connectors' wiring direction) – clamping units labeled via marking strips (210-334)

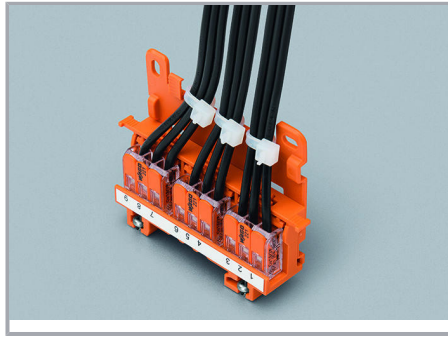

Vertical screw mounting with strain relief

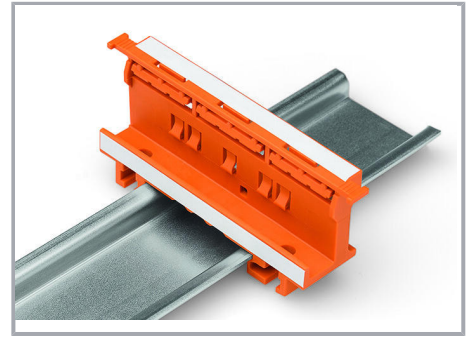

Mounting carrier on a DIN-35 rail

Testing

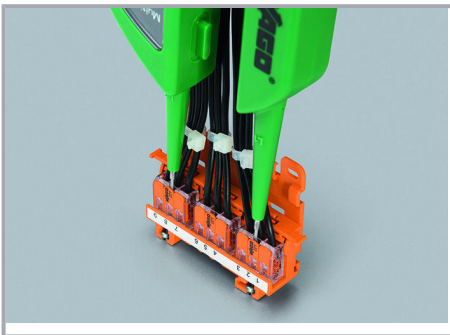

Testing connectors via test slots on top of the carrier.

Supus modificărilor. Vă rugăm să respectați și celelalte documentații ale produsului!