

SECTION A-A

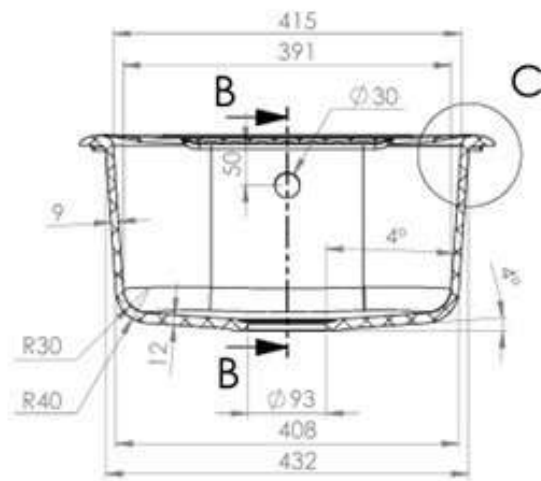

SECTION B-B

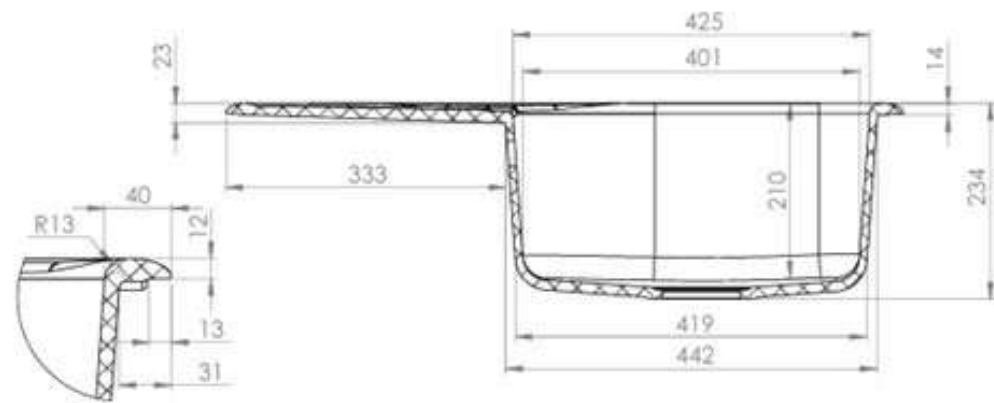

DETAIL C
SCALE 1 : 3

